

■ 枠無し縦格子 - 格子20×40 / 30×50 / 50×50

□ 格子20×40

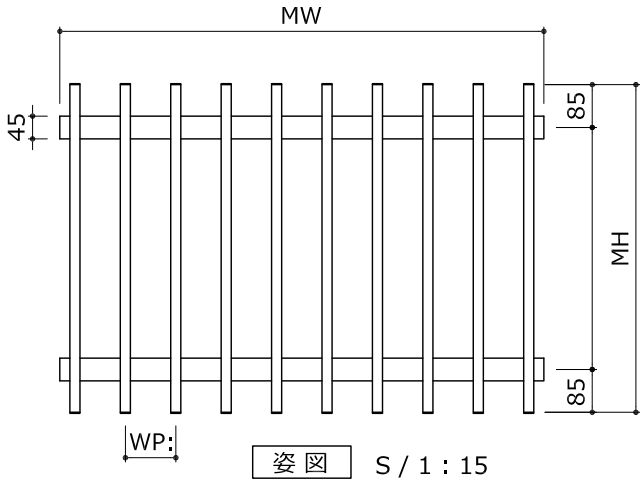

□ 格子30×50

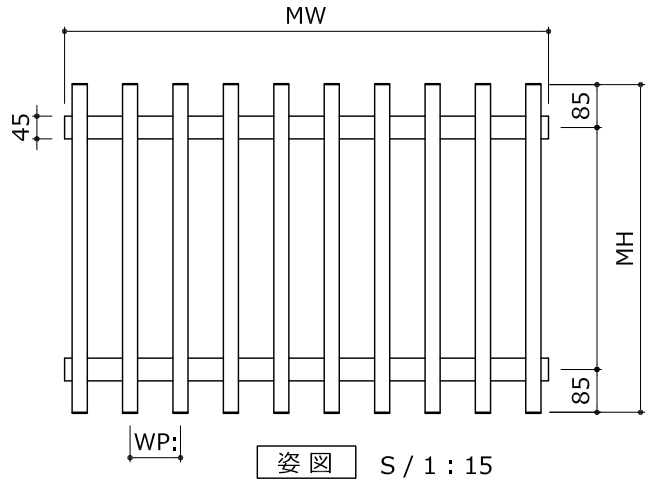

□ 格子50×50

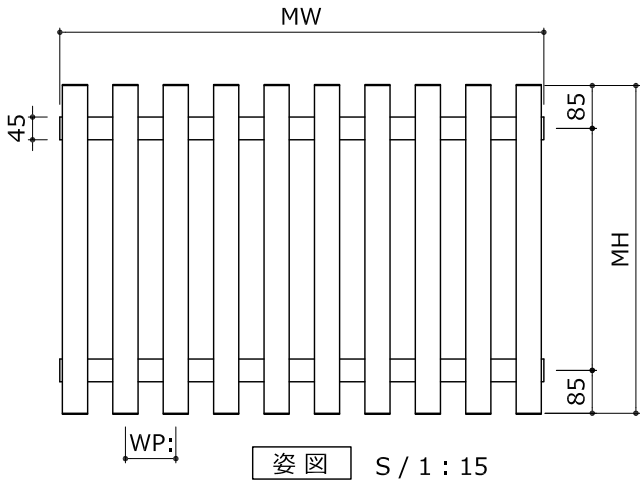

□ 枠材バリエーション

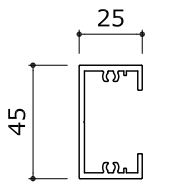

W材45×25

□ 格子材バリエーション

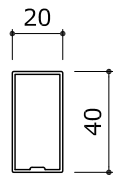

□20×40

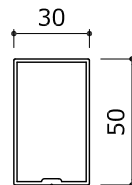

□30×50

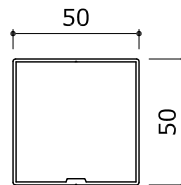

□50×50

□ 標準格子ピッチ



□ 取付金具

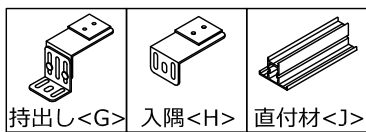

※ブラケット部品図・納まり図を参照ください。

□ 製作範囲

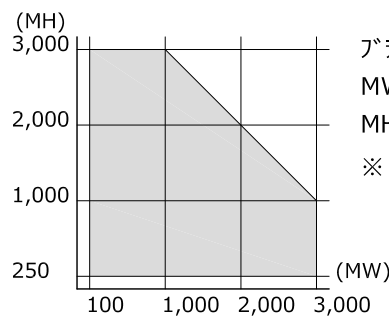

ブラケット数 (基本4個付)
MW 2,501mm以上 : +2個
MH 1,501mm以上 : +2個
※ H=1,501mm以上は、
中棧が入ります。

□ 持出し納まり

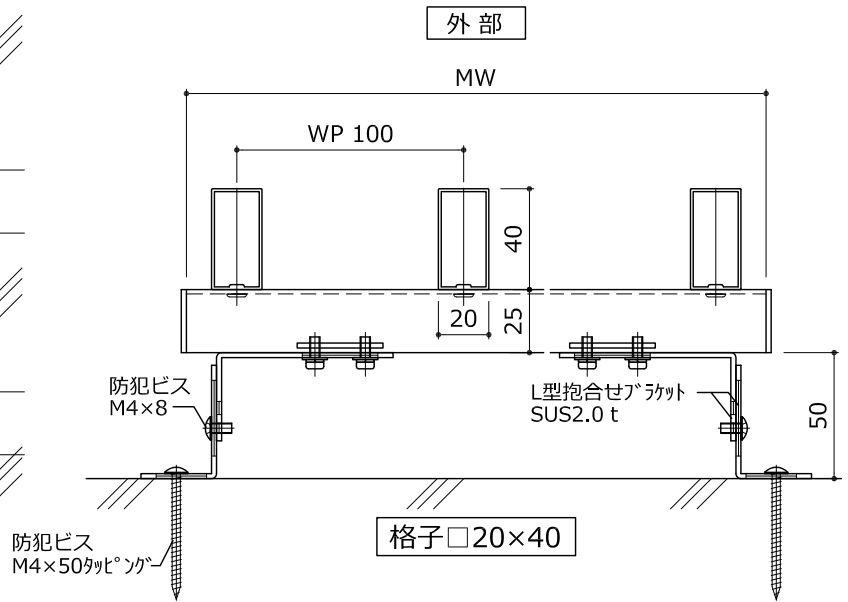
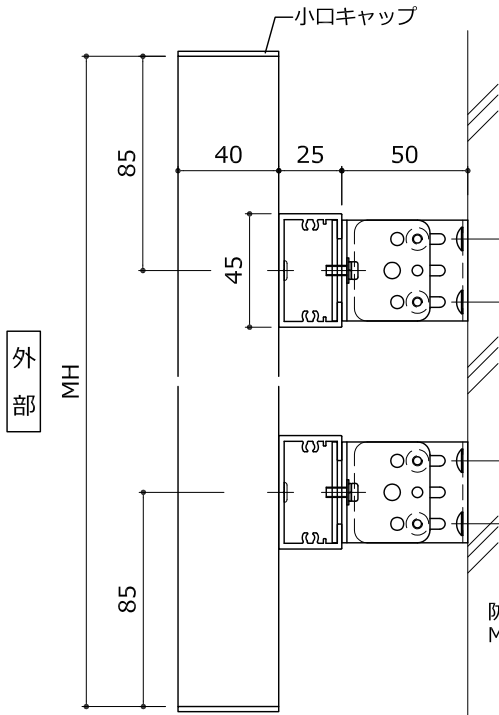

□ 木造躯体直付け

